



Components for the food industry. [Reliable technology and sanitary design.](#)

➤➤ Bulk material components for conveying and discharging foodstuffs must satisfy very high demands with regard to sanitation and reliability. Coperion is the right partner for all such applications.

Coperion is the worldwide leading manufacturer of bulk material components, and is familiar with the properties and behaviour of more than 10,000 different bulk materials. Parameters such as particle size, cohesion and adhesion influence the flow properties and therefore the correct design and layout of bulk material components. Our intensive research and the

development of new technologies has resulted in innovative and easy-to-clean process components produced on our own premises which set standards in the industry. This means that your products are handled as sanitary and gently as possible in keeping with the very latest technical standards.

EXAMPLE APPLICATIONS FOR OUR COMPONENTS

> LOGISTICS SYSTEM

- 1 Rotary valve
- 2 Diverter valve
- 3 Slide gate valve
- 4 Sampler

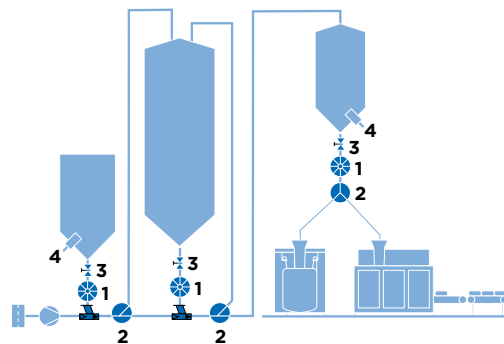

> MILL WITH EXPLOSION PROTECTION

- 1 Rotary valve as ATEX protection system
- 2 Slide gate valve

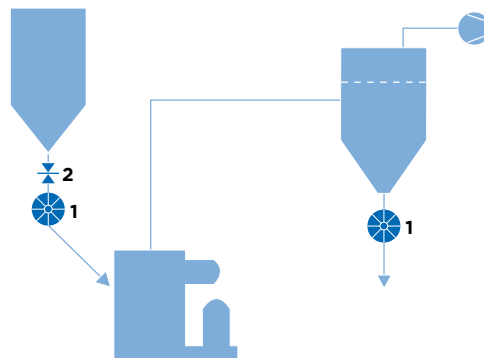

> SPRAY-DRYING SYSTEM

- 1 Rotary valve for CIP application
- 2 Diverter valve for CIP application

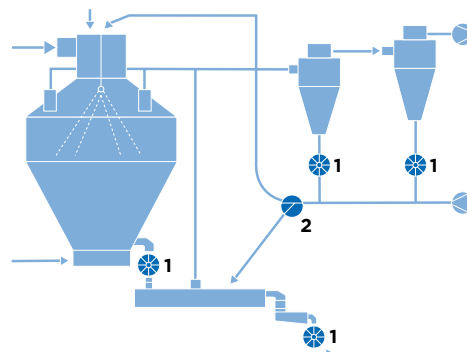

EXAMPLES OF CONVEYED PRODUCTS:

Dairy products

- > Milk powder
- > Whey powder
- > Lactose
- > Babyfood
- > Casein
- > ...

Starch

- > Maize starch
- > Potato starch
- > Wheat starch
- > Modified starch
- > Dextrine
- > ...

Basic materials and additives

- > Sugar
- > Flour
- > Coffee beans and ground coffee
- > Malt
- > Cocoa beans and powder
- > Salt
- > Rice
- > Tea
- > Tobacco
- > Soya beans
- > Nuts
- > Herbs
- > Pectin
- > Gelatine
- > ...

Convenience products

- > Cake mixes and baking powder
- > Soups
- > Instant potato
- > Instant products
- > Breadcrumbs
- > Spices and mixed spices
- > Cereals
- > Pet food
- > ...

PERFECT CONVEYING AND DISCHARGE: COPERION ROTARY VALVES

BLOW-THROUGH VALVE

ZXD FOR POWDER

- › Optimum chamber emptying with specially designed blow-through channel, ideal for products with poor flow properties
- › Extra-large inlet for high throughputs
- › Can be used without leakage gas collector



DISCHARGE AND CONVEYING VALVE

ZRD FOR POWDER

- › Smooth surfaces
- › Outside bearings, gas-purged
- › With pick-up tee for pneumatic conveying systems up to +1.5 bar (g)



DISCHARGE AND CONVEYING VALVE

ZVD FOR POWDERS AND COARSE PRODUCTS

- › Product-gentle inlet geometry
- › Start-up from a stationary product column
- › Integrated leakage gas venting



- › Materials available: stainless steel, aluminium, grey cast iron, chrome-plated grey cast iron, nickel-plated grey cast iron
- › Option: surfaces with wear protection or Teflon coating
- › Hygienic series: polished surfaces ($R_a \leq 0,8 \mu\text{m}$)
- › All rotary valves suitable for pneumatic conveying up to 1.5 bar (g)

OPTIONS:

QUICK-CLEANING

- › Fast and simple cleaning:
- › Rotor with quick coupling
- › FullAccessSystem FXS-1 hinge extraction device
- › Removable rotor
- › Hinged drive side plate FXS-2
- › Cleaning cover

CERTIFIED ROTARY VALVES ESPECIALLY FOR CLEANING IN PLACE

- › Ideal for the highest sanitary and product quality demands
- › For fully automatic wet cleaning without dismantling the valve
- › For frequent cleaning – saves time and money
- › EHEDG approved and certified (EL Class I)

ACCESSORIES

- › Chamfered rotor blades
- › Rotor with scraper blades for caking products
- › Rotor with reduced volume
- › Wear-protected versions
- › RotorCheck: electronic contact monitoring of rotor and housing

ATEX-CERTIFIED VERSIONS

- › Inside: zone 0/20 (II1GD), Outside: zone 1/21 (II1GD), or zone 2/22 (II3GD)
- › ATEX protection system: pressure surge-proof up to +10 bar and flame surge-proof St1 and St2

› QUICK-CLEANING

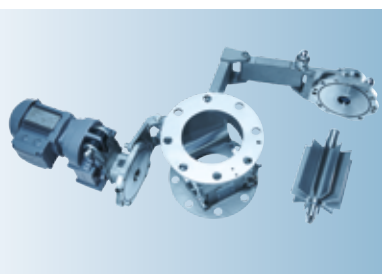

› CLEANING IN PLACE

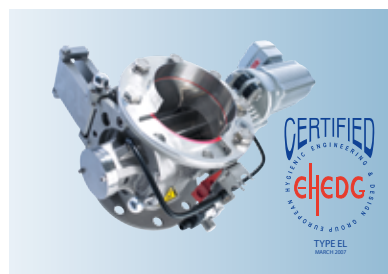

› ACCESSORIES

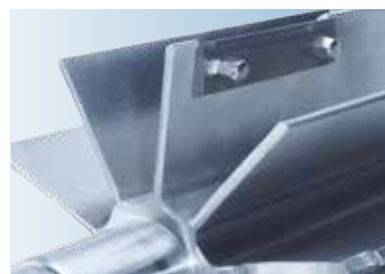

› ATEX

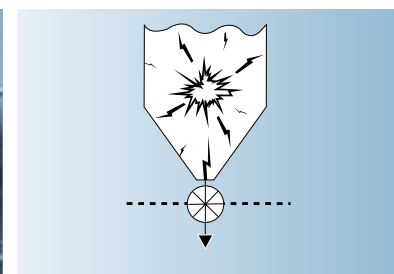

GIVING THE RIGHT DIRECTION: COPERION DIVERTER VALVES

TWO-WAY DIVERTER VALVE WZK

- › Parts in contact with product made of stainless steel, aluminium housing
- › DN 50 (2") to DN 265 (10")
- › For pneumatic conveying systems up to +5 bar
- › Smooth, easy-to-clean surfaces



TWO-WAY DIVERTER VALVE WYK

- › Made entirely of stainless steel
- › DN 65 (2.5") to DN 125 (5")
- › For pneumatic conveying systems up to +5 bar
- › Also available as WYK-CIP for cleaning in place!

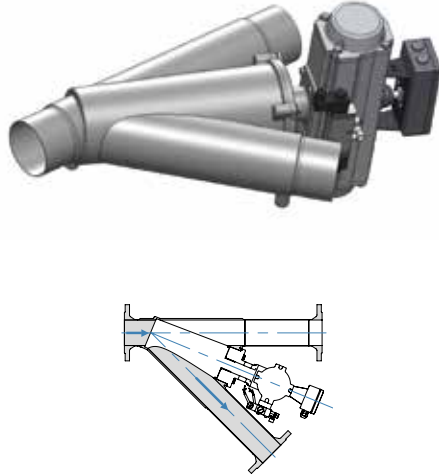

TWO-WAY DIVERTER VALVE WHK

- › Made entirely of stainless steel
- › DN 150 (6") to DN 350 (14")
- › For gravity pipes or pneumatic conveying systems up to +3 bar

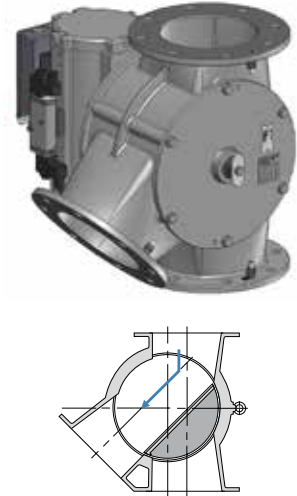

QUICK-CLEANING AS STANDARD FEATURE:

The cover can be opened quickly and easily and the rotary element can be removed, making cleaning and inspection fast and simple.

OPTIONAL: CIP-CERTIFIED DIVERTER VALVE WYK

- › For the highest sanitary and quality requirements
- › CIP design and CIP drive permit fully-automatic wet cleaning without dismantling the valve
- › Certified for CIP by the EHEDG (EL Class I)

EXAMINE PRODUCT QUALITY: SAMPLER PN 80

- › For regular extraction of product samples from the silo cone or gravity pipe
- › Material: aluminium or stainless steel
- › Option: quick cleaning

SHUTTING OFF PRODUCT FLOW: SLIDE GATE VALVE FUS

- › Basic shut-off slide valve for silos and hoppers
- › DN 100 (4") to DN 600 (24")
- › Made of stainless steel

› WYK-CIP (DISMANTLED)

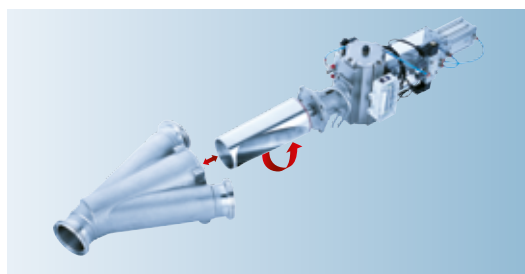

› SAMPLER

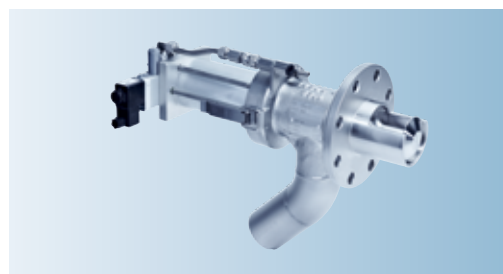

› SLIDE GATE VALVE



➤➤ Innovative technology for optimum operational safety: Coperion components for the food industry. With our many years of experience and all-around process know-how we are able to supply individual and efficient solutions for your production which are operationally safe and reliable, sanitary and easy to clean.

YOUR BENEFITS:

- › Sanitary product design
- › Operational reliability and durability
- › Easy to clean: fast, efficient cleaning and inspection due to optimum accessibility
- › Certified CIP versions (cleaning in place)

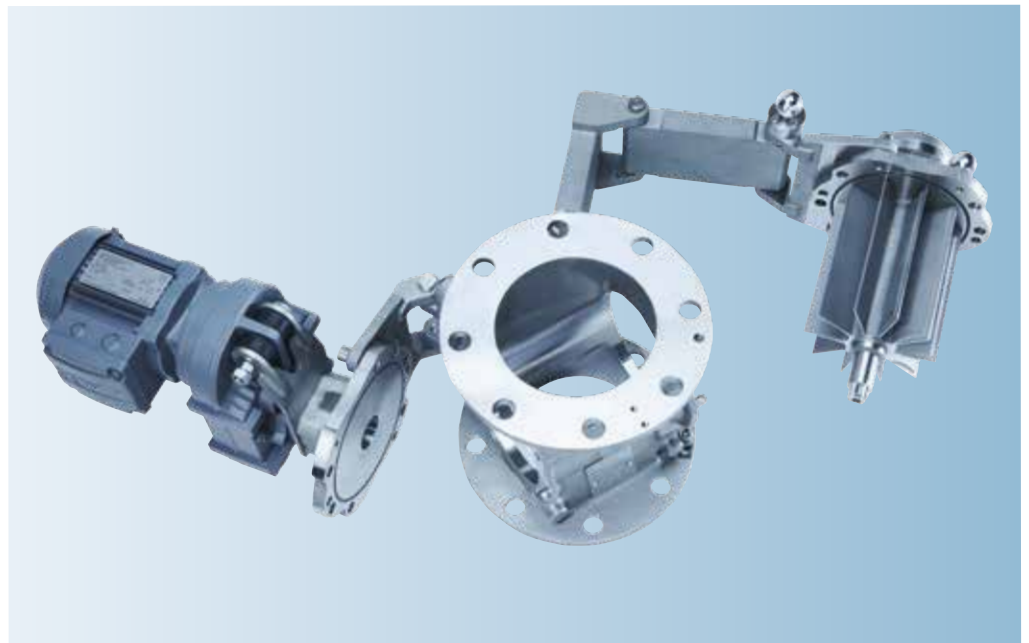

EHEDG AND USDA COMPLIANT AND CERTIFIED VERSIONS AVAILABLE

Coperion is an active member of the European Hygienic Engineering & Design Group. The latest developments and directives are therefore directly incorporated into the development of all components.

The USDA (United States Department of Agriculture) Dairy Grading Branch certifies components on the basis of stringent regulations regarding sanitary and easy-clean design.



Coperion GmbH

Theodorstrasse 10
70469 Stuttgart, Germany
Tel.: +49 711 897-0
Fax: +49 711 897-3999

Coperion GmbH

Niederbieger Strasse 9
88250 Weingarten, Germany
Tel.: +49 751 408-0
Fax: +49 751 408-200

info@coperion.com
www.coperion.com

> Europe

Belgium, Luxembourg, Netherlands
Coperion N.V.
Industrieweg 2, 2845 Niel, Belgium
Tel.: +32 3 870-5100
Fax: +32 3 877-0710

France

Coperion S.a.r.l.
56 boulevard de Courcerin
77183 Croissy-Beaubourg, France
Tel.: +33 164 801 600
Fax: +33 164 801 599

Germany

Coperion GmbH
Germany West Office
Industriestrasse 71a
50389 Wesseling, Germany
Tel.: +49 2232 20700-10
Fax: +49 2232 20700-11

Coperion Pelletizing Technology GmbH

Heinrich-Krumm-Strasse 6
63073 Offenbach, Germany
Tel.: +49 69 989 5238-0
Fax: +49 69 989 5238-25

Coperion K-Tron Deutschland GmbH

Heinrich-Krumm-Strasse 6
63073 Offenbach, Germany
Tel.: +49 69 8300 899-0
Fax: +49 69 8300 9498

Italy

Coperion S.r.l.
Via E. da Rotterdam, 25
44122 Ferrara, Italy
Tel.: +39 0532 7799-11
Fax: +39 0532 7799-80

Coperion S.r.l.
Milan Office

Via XXV Aprile, 49
20091 Bresso (MI), Italy
Tel.: +39 02 241 049-01
Fax: +39 02 241 049-22

Russian Federation, CIS

OOO Coperion
Proezd Serebryakova 14,
Bld. 15, Office 219
129343 Moscow, Russian Federation
Tel.: +7 499 258 4206
Fax: +7 499 258 4206

Spain, Portugal

Coperion, S.L.
Balmes, 73, pral.
08007 Barcelona, Spain
Tel.: +34 93 45173-37
Fax: +34 93 45175-32

Switzerland

Coperion K-Tron (Schweiz) GmbH
Lenzhardweg 43/45
5702 Niederlenz, Switzerland
Tel.: +41 62 8857-171
Fax: +41 62 8857-180

United Kingdom

Coperion Ltd.
Coperion K-Tron Great Britain Ltd.
Unit 4, Acorn Business Park
Heaton Lane
Stockport, SK4 1AS, United Kingdom
Tel.: +44 161 209 4810
Fax: +44 161 474 0292

> Asia

China

Coperion (Nanjing) Machinery Co. Ltd.
No. 1296 Jiyin Avenue
Jiangning District
Nanjing 211106, PR China
Tel.: +86 25 5278 6288
Fax: +86 25 5261 1188

Coperion International Trading (Shanghai) Co. Ltd.

Coperion Machinery & Systems (Shanghai) Co. Ltd.
Bldg. A2, 6000 Shenzhuan Road
Dongjing Town, Songjiang District
Shanghai 201619, PR China
Tel.: +86 21 6767 9505
Fax: +86 21 6767 9108

Coperion K-Tron (Shanghai) Co. Ltd.

Building A2-A3
No. 6000 Shen Zhuan Gong Road
Songjiang District
201619 Shanghai, PR China
Tel.: +86 21 6375 7925
Fax: +86 21 6375 7930

India

Coperion Ideal Pvt. Ltd.
Ideal House, A-35, Sector 64
201307 Noida (U.P.), India
Tel.: +91 120 4299 333
Fax: +91 120 4308 583

Japan

Coperion K.K.
4F, Leaf Square Shin-Yokohama Bldg.
3-7-3, Shin-Yokohama,
Kohoku-ku Yokohama,
Kanagawa 222-0033, Japan
Tel.: +81 45 595 9801
Fax: +81 45 595 9802

Saudi Arabia

Coperion Middle East Co. Ltd.
Street # 327, Sector G, Block 2, Lot # 31
Jubail 2 Industrial City,
Kingdom of Saudi Arabia
Tel.: +966 13 510 4420
Fax: +966 13 510 4421

Singapore

Coperion Pte. Ltd.
Coperion K-Tron Asia Pte. Ltd.
8 Jurong Town Hall Road
#28-01/02/03 The JTC Summit
Singapore 609434
Tel.: +65 641 88-200
Fax: +65 641 88-203

Taiwan

Coperion (Nanjing) Machinery Co. Ltd.
Taiwan Branch Office
5F, No. 43, Alley 115
Chung San North Road Sec. 2
Taipei, Taiwan
Tel.: +886 2 2521 3580
Fax: +886 2 2521 1604

> America

South America

Coperion Ltda.
R. Arinos, 1000
RBCA - Royal Business Center
Anhanguera, Módulo 4
Parque Industrial Anhanguera
06276-032 Osasco - SP, Brazil
Tel.: +55 11 3874-2740
Fax: +55 11 3874-2757

USA, Canada, Mexico, NAFTA
Coperion Corporation
590 Woodbury Glassboro Road
Sewell, NJ 08080, USA
Tel.: +1 201 327-6300
Fax: +1 201 825-6494

Coperion Corporation Wytheville Office

196 Appalachian Drive
Wytheville, VA 24382, USA
Tel.: +1 276 228-7717
Fax: +1 276-227-7044

Coperion Corporation Houston Office

7900 North Sam Houston Pkwy, West
Suite 202
Houston, TX 77064, USA
Tel.: +1 281 449-9944
Fax: +1 281 449-4599

Coperion K-Tron Pitman, Inc.

590 Woodbury Glassboro Road
Sewell, NJ 08080, USA
Tel.: +1 856 589-0500
Fax: +1 856 589-8113

Coperion K-Tron Salina, Inc.

606 North Front Street
Salina, KS 67401, USA
Tel.: +1 785 825-1611
Fax: +1 785 825-8759

For more information about
the worldwide Coperion network,
visit www.coperion.com